

Marble Pump Version 1.01

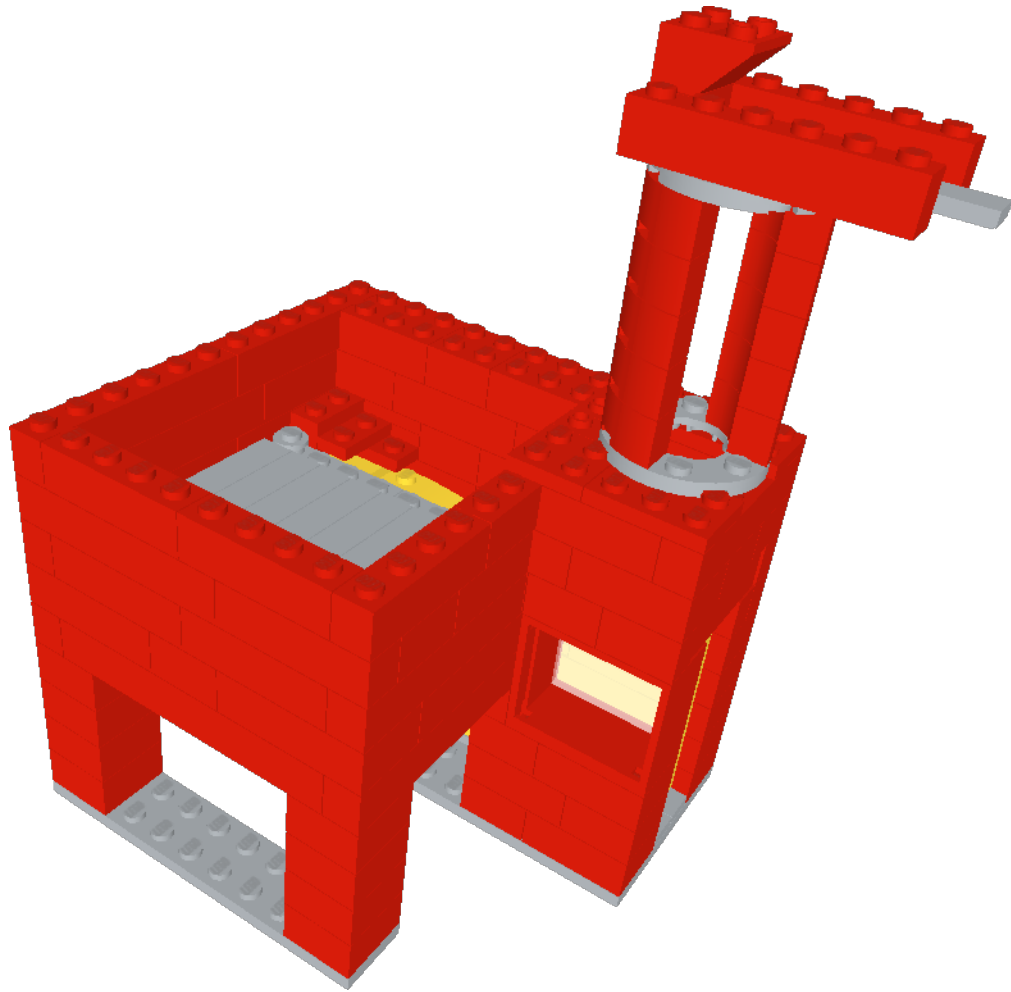

by Brian Alano

My rendition of the classic marble pump

Adaptable design

Basic bricks

Not pretty. That's your job.

Released in 2014 under Creative Common 3.0 Attribution License

1

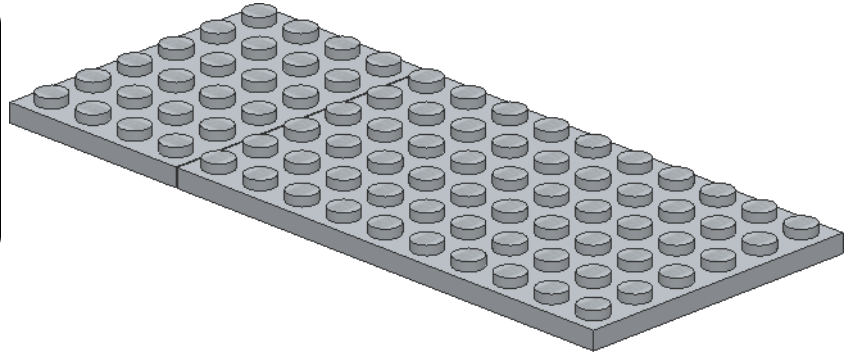
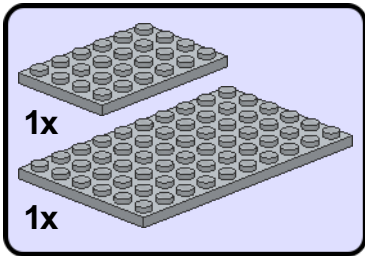

2

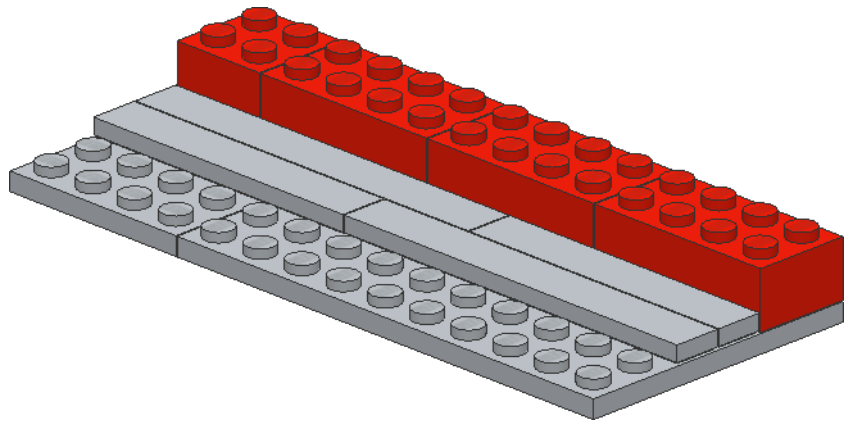
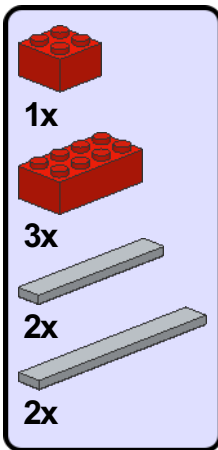

3

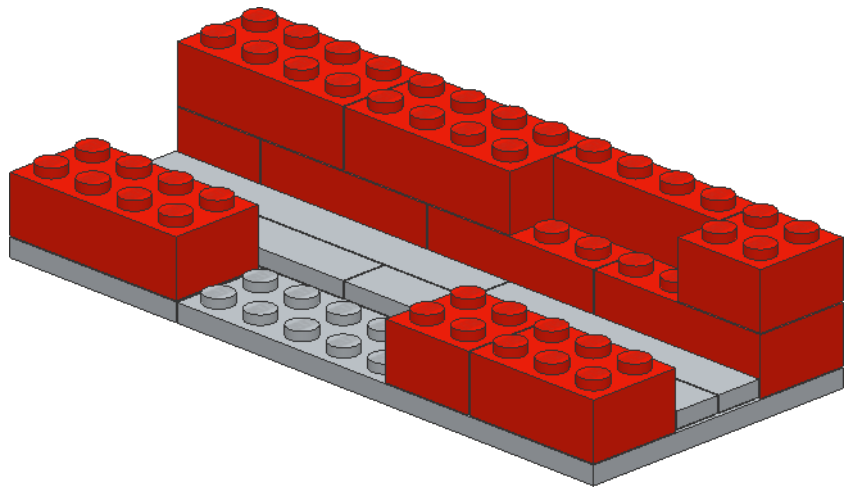
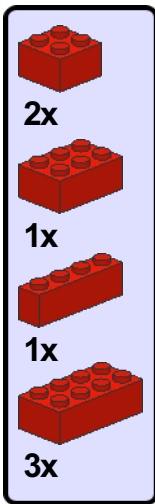

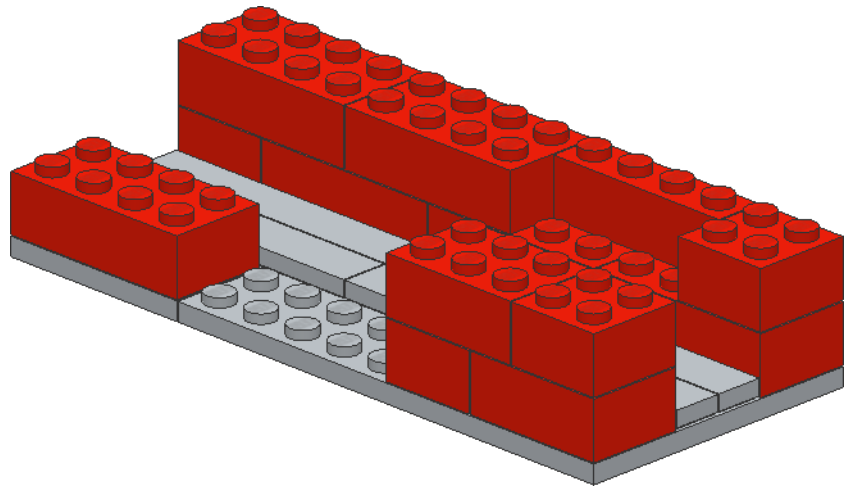
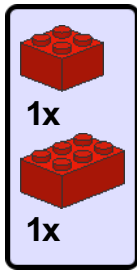

4

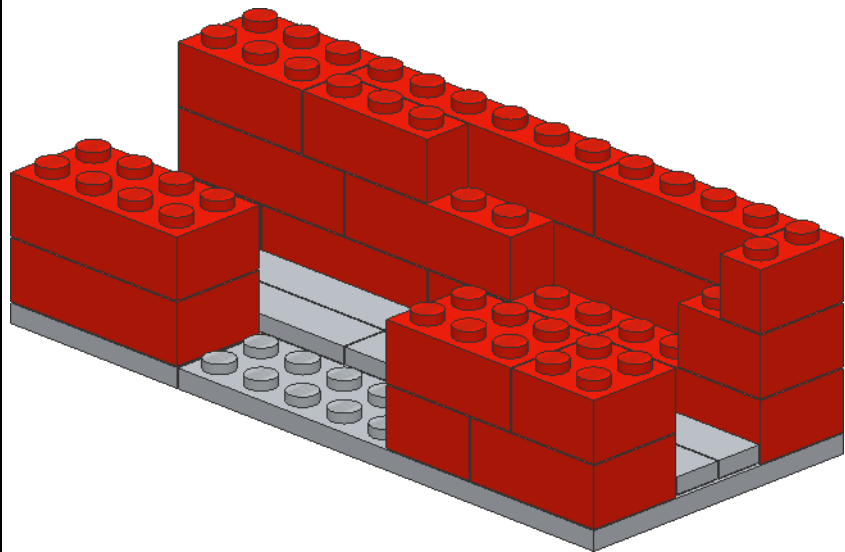
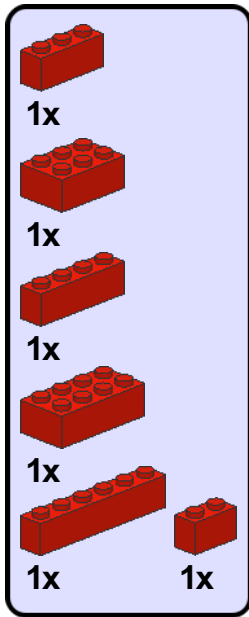

5

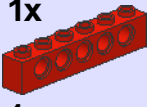

1

-  1x 3
-  1x
-  1x

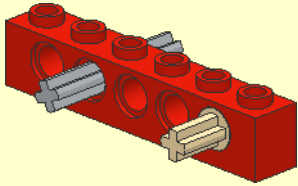

2

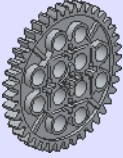
-  1x
-  1x

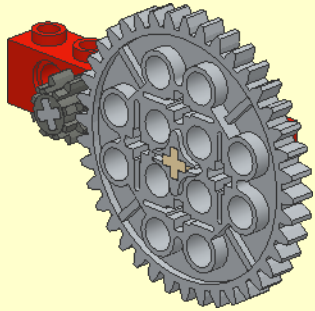

3

-  1x

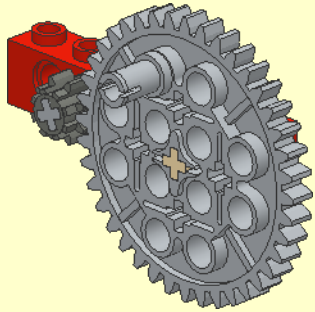

4

-  1x
-  2x
-  1x

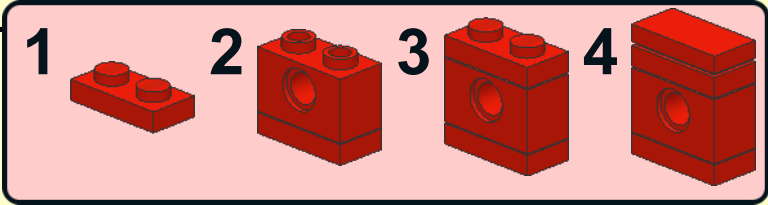
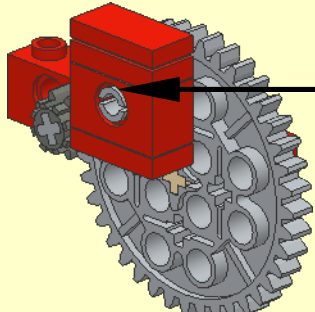

5

-  2x

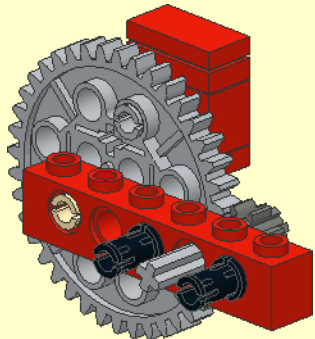

6

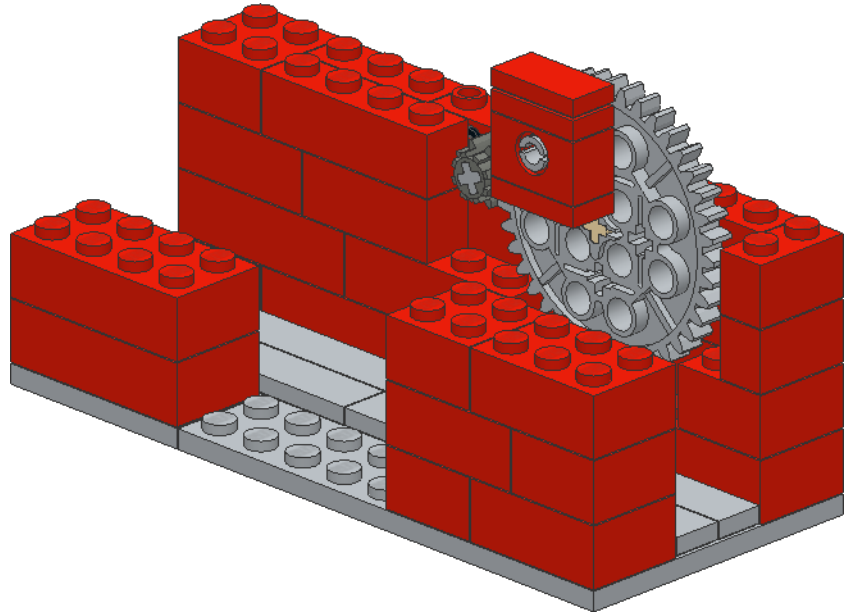
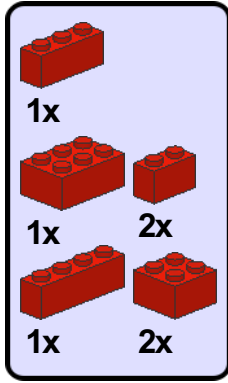



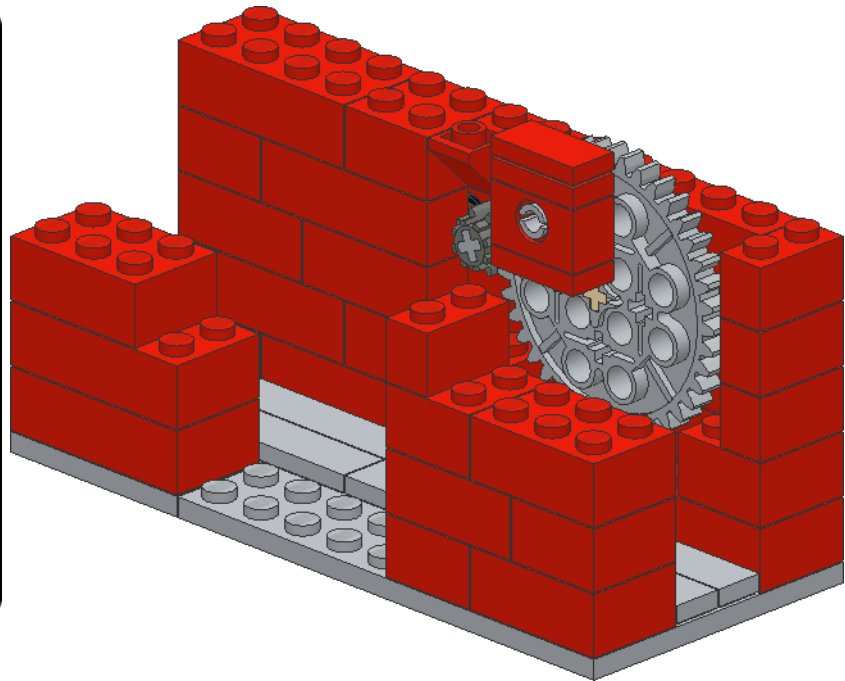
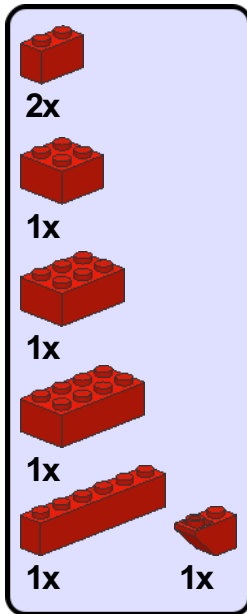

7

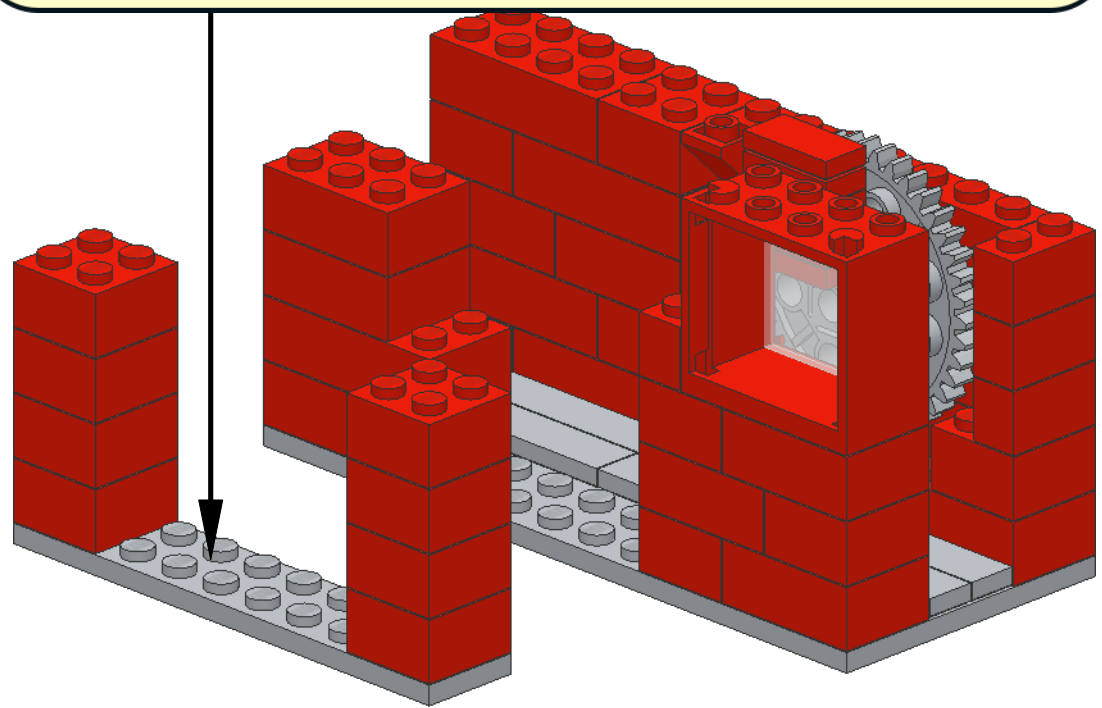
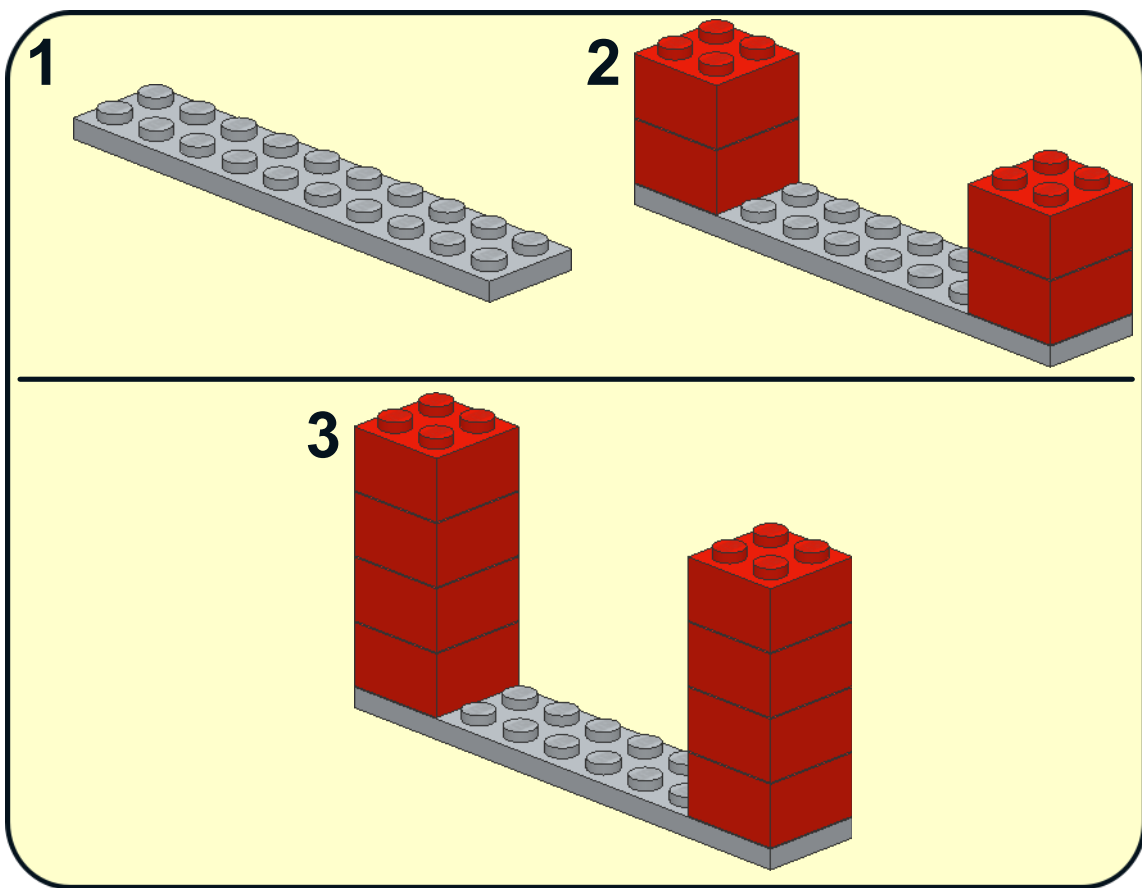
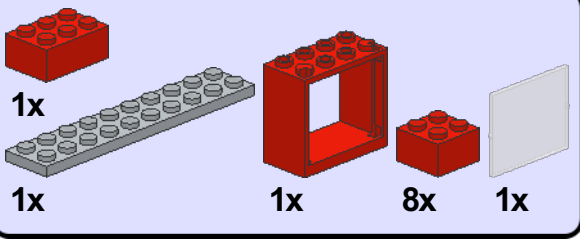

8



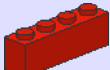
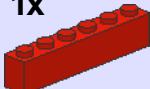
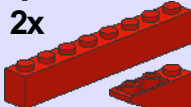

9

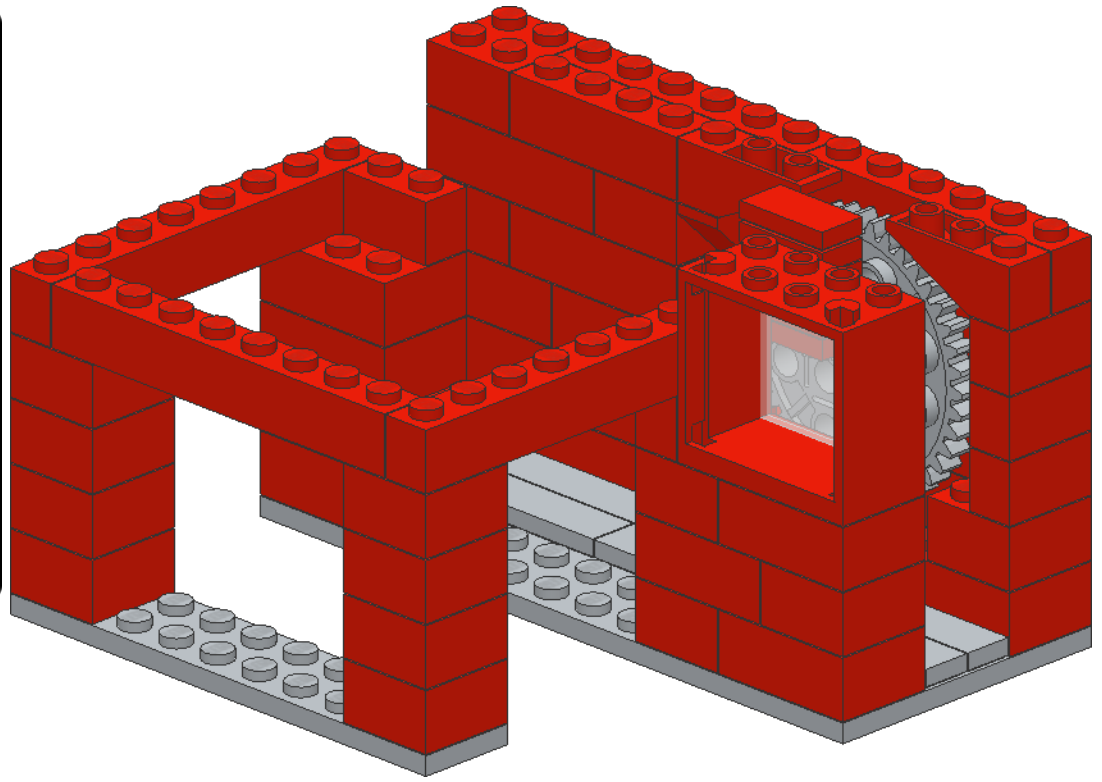
- 1x 
- 1x 
- 1x 
- 2x 
- 3x 
- 2x 

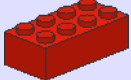
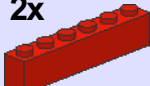

10

- 1x 
- 1x 
- 2x 
- 2x 

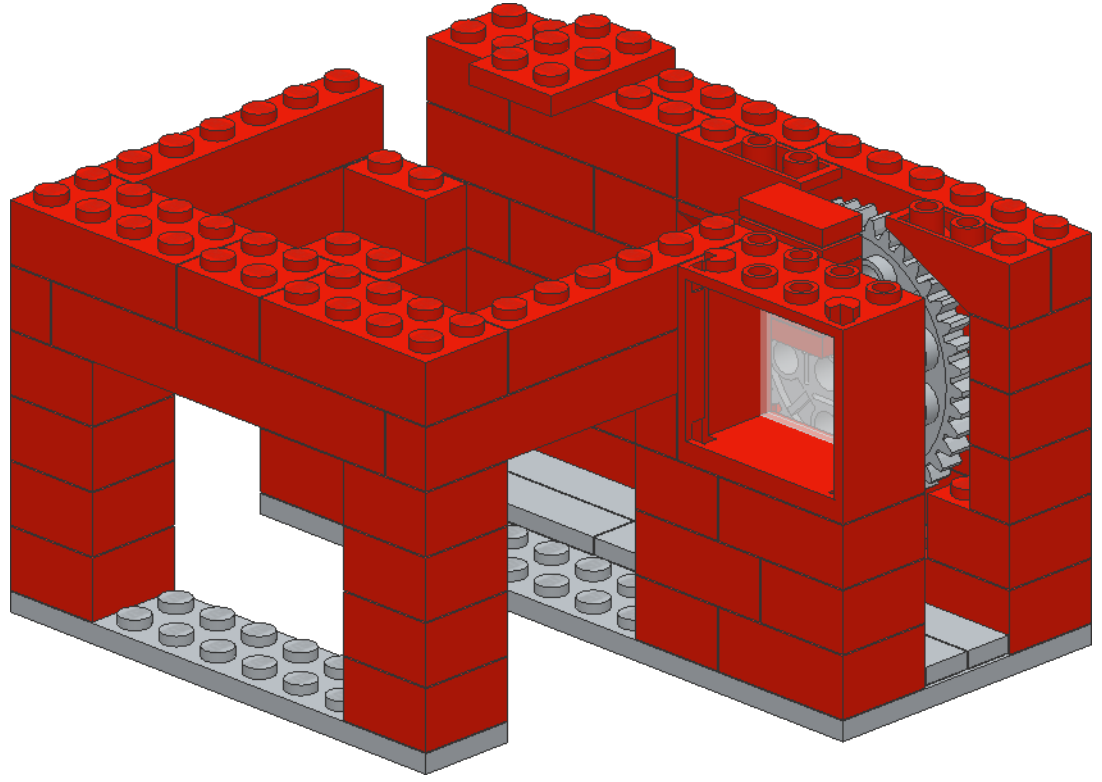

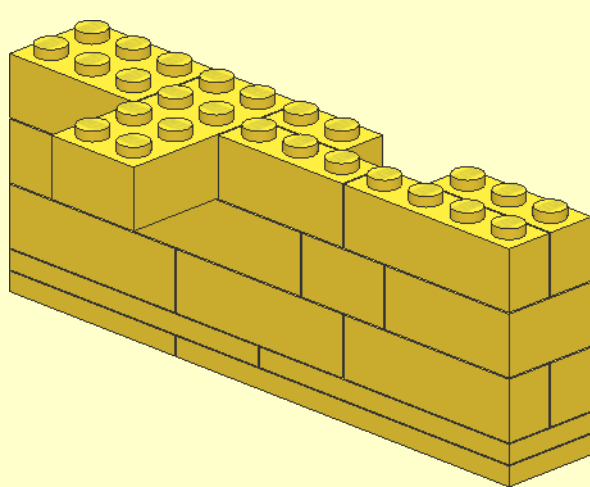
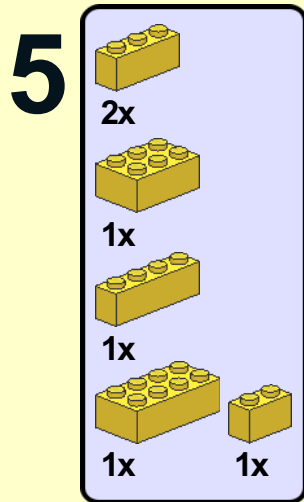
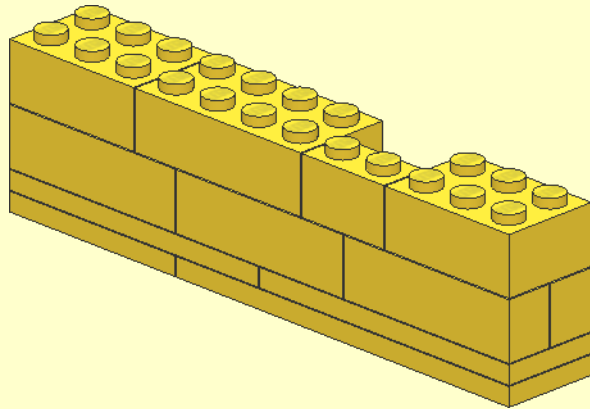
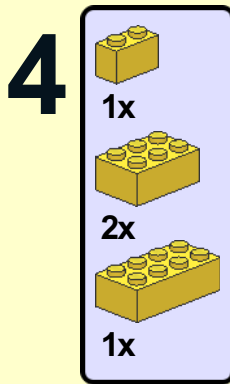
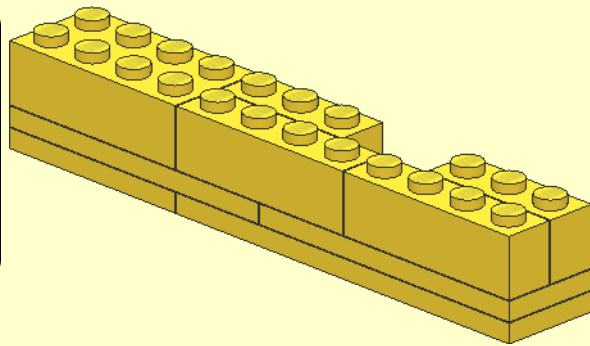
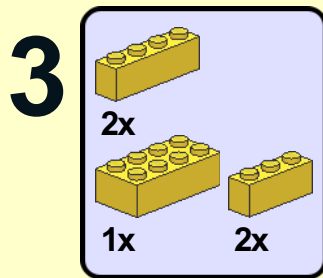
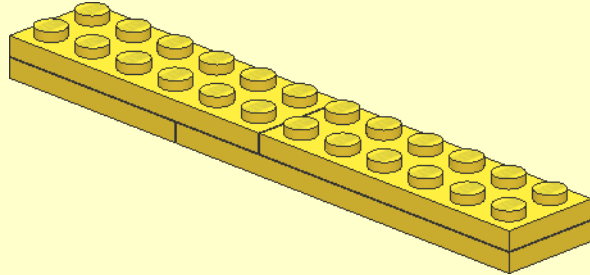
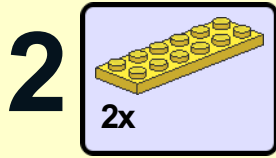
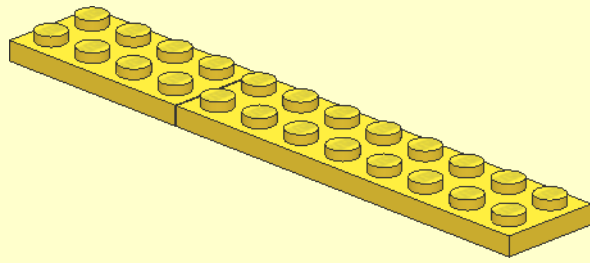
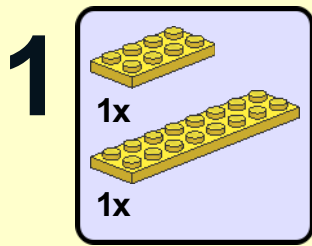

6

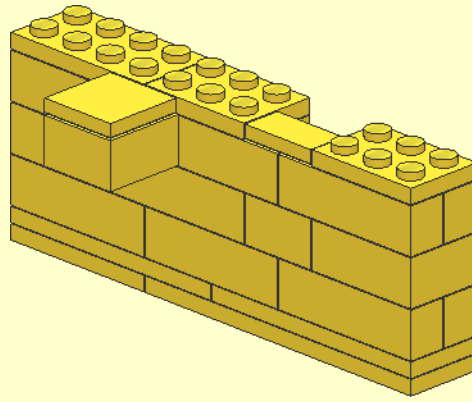
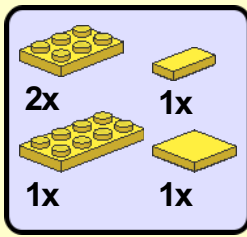

7

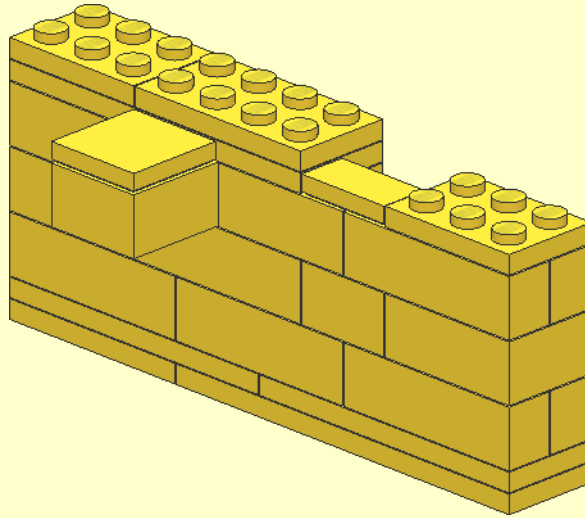
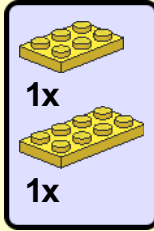

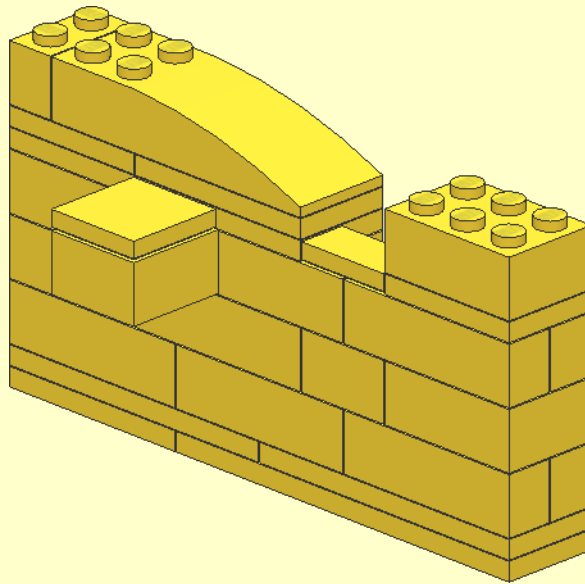
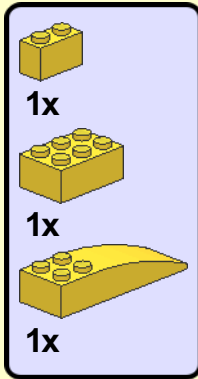

8

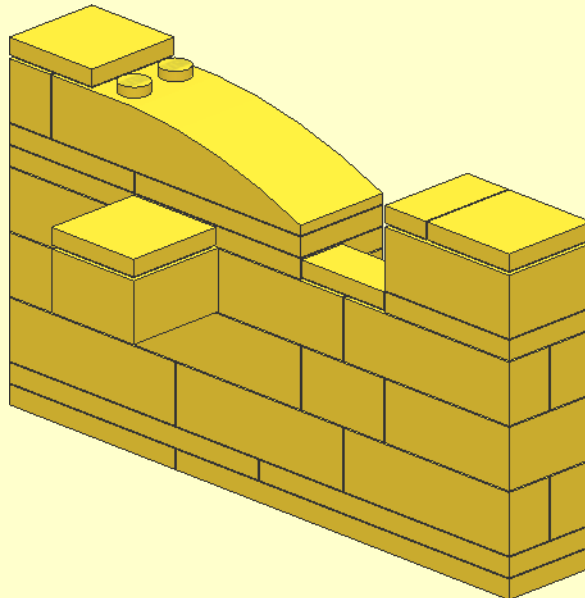
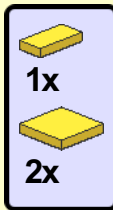

9

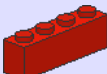
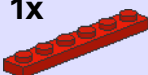
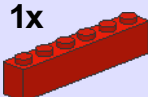

11

- 3x 
- 1x 
- 1x 
- 1x 
- 2x 

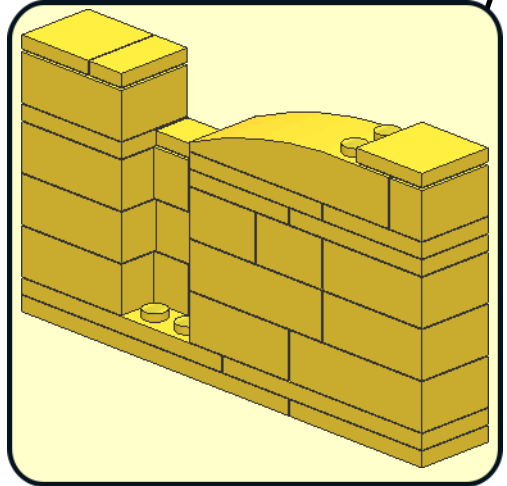
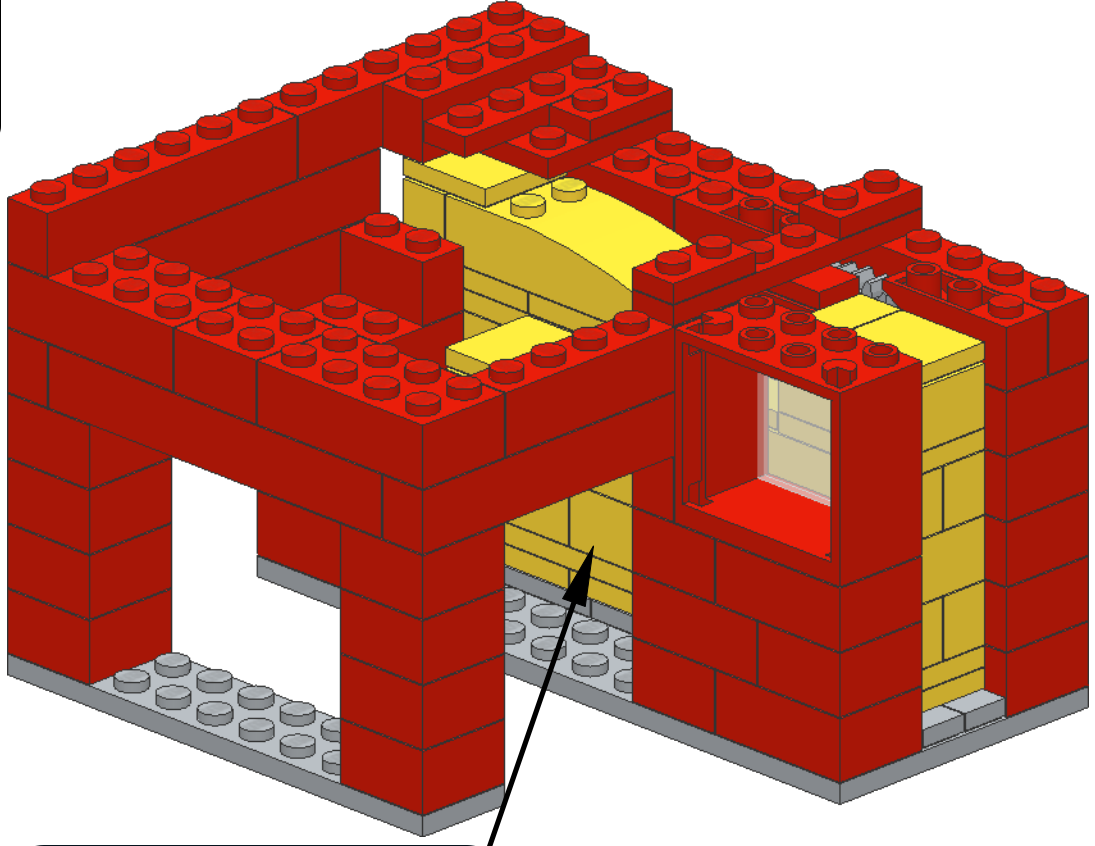

12

1x
2x
1x
8x
2x
1x

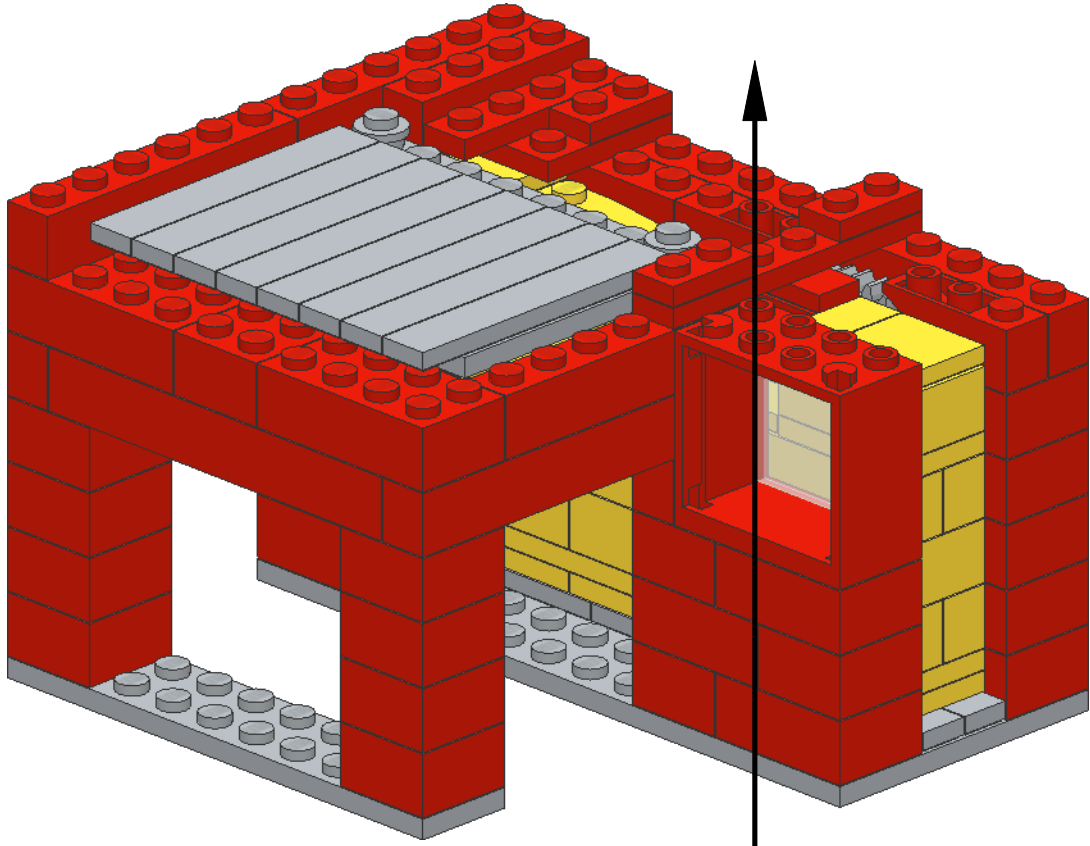

1

2

3

4

5

6

13

- 2x
- 2x
- 1x
- 3x
- 1x
- 2x
- 1x

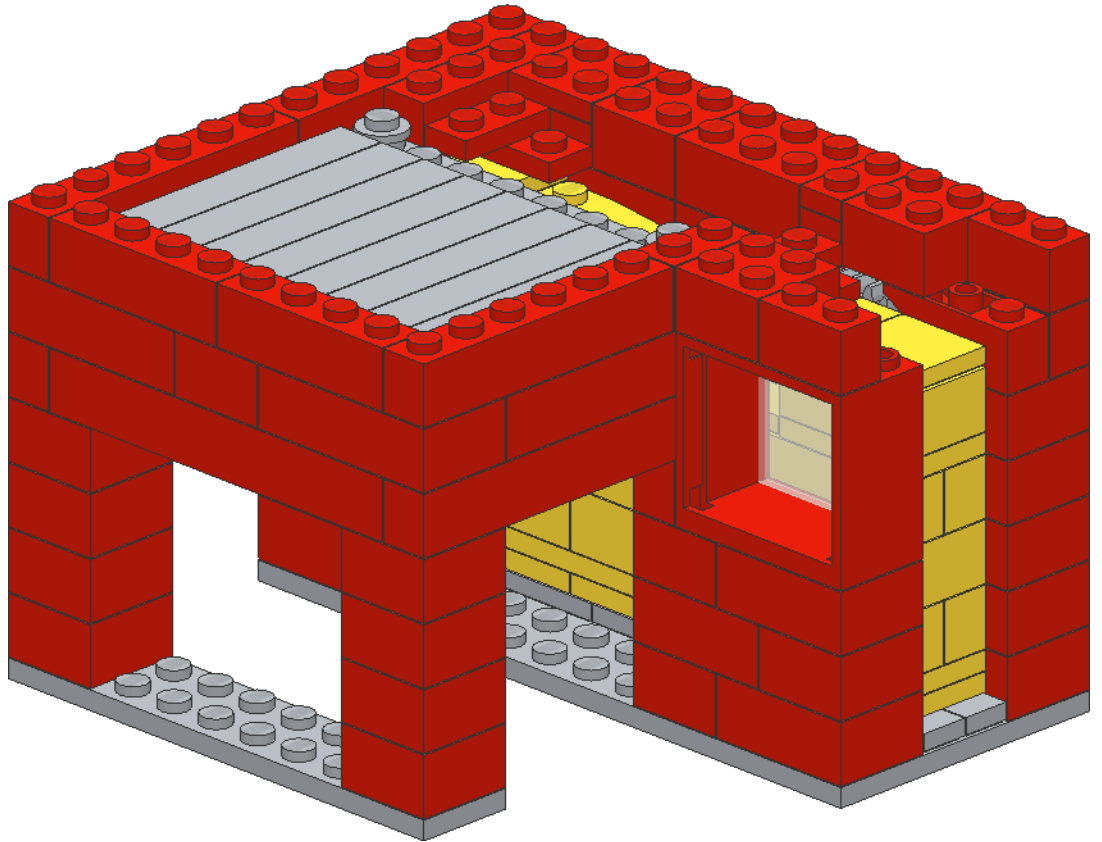

14

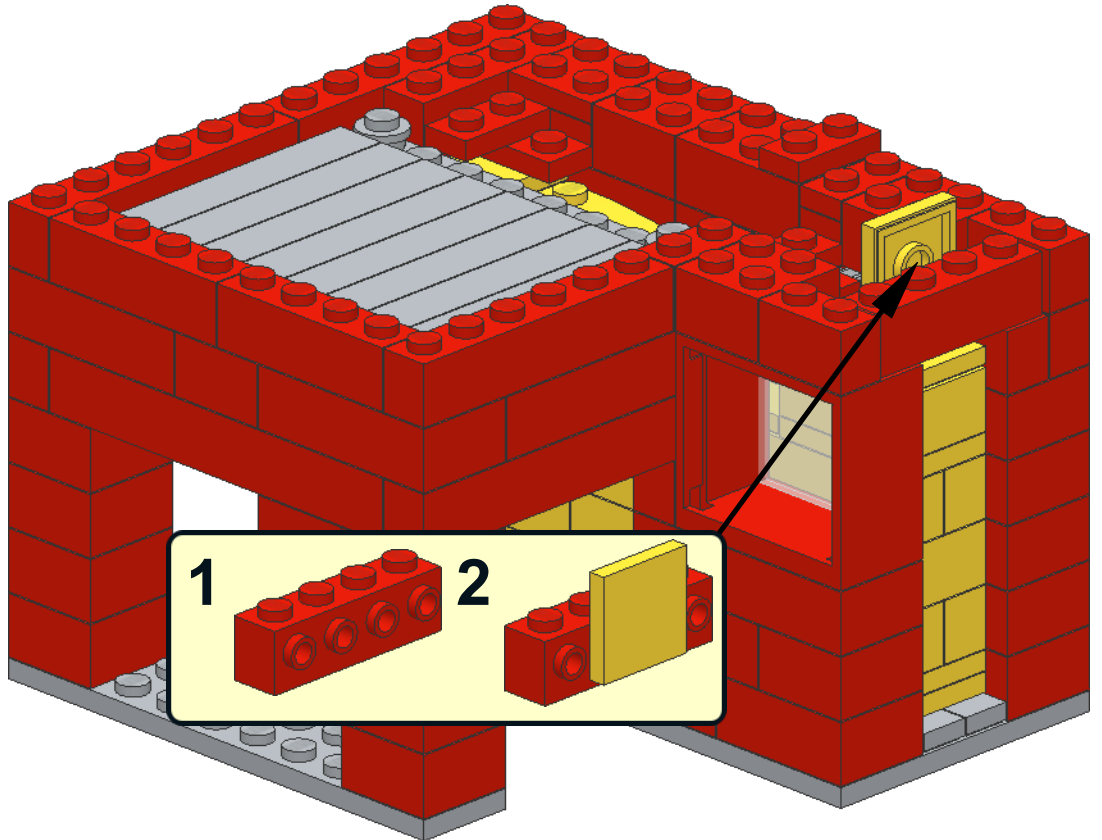

- 1x
- 1x
- 1x
- 1x

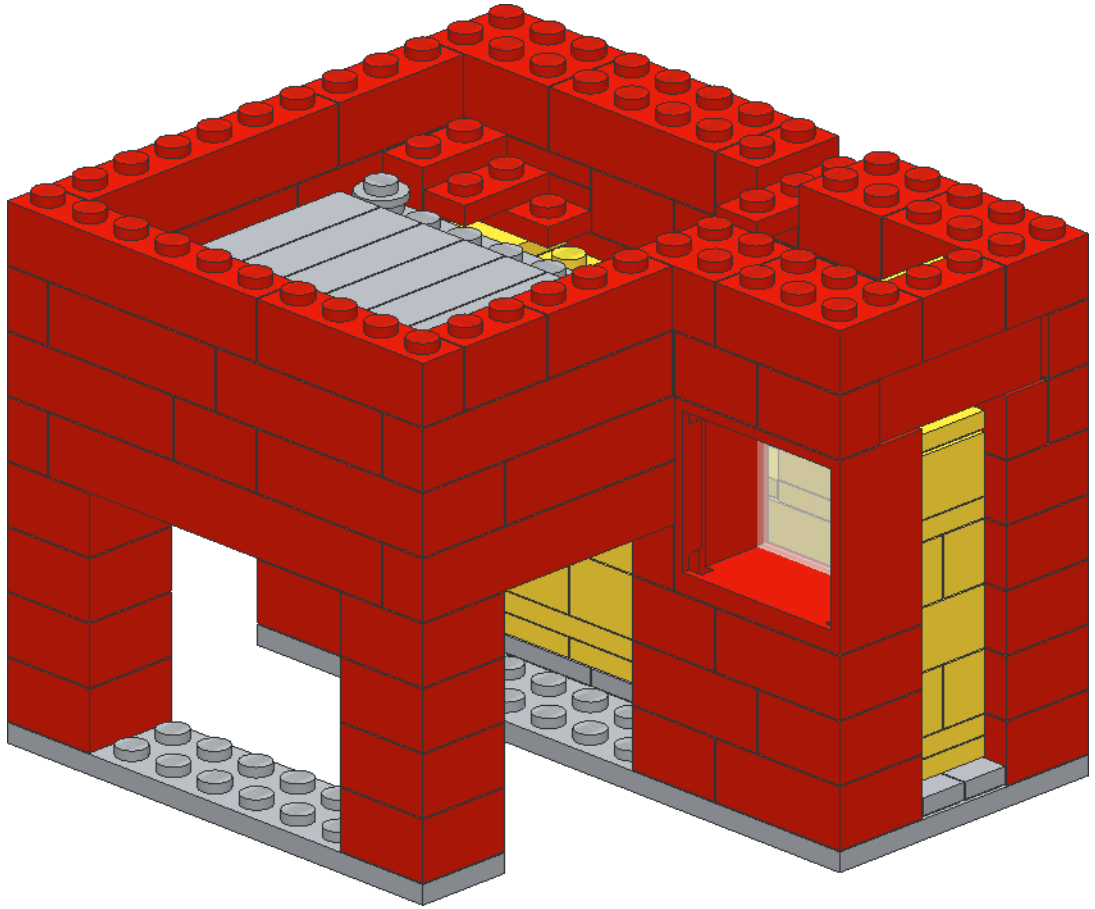
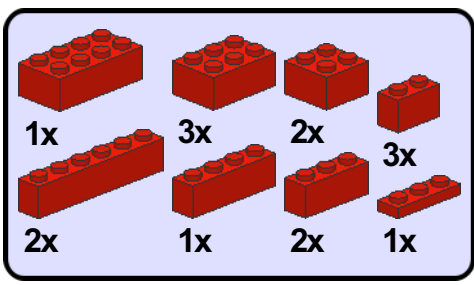

15



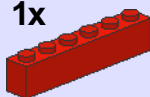

16

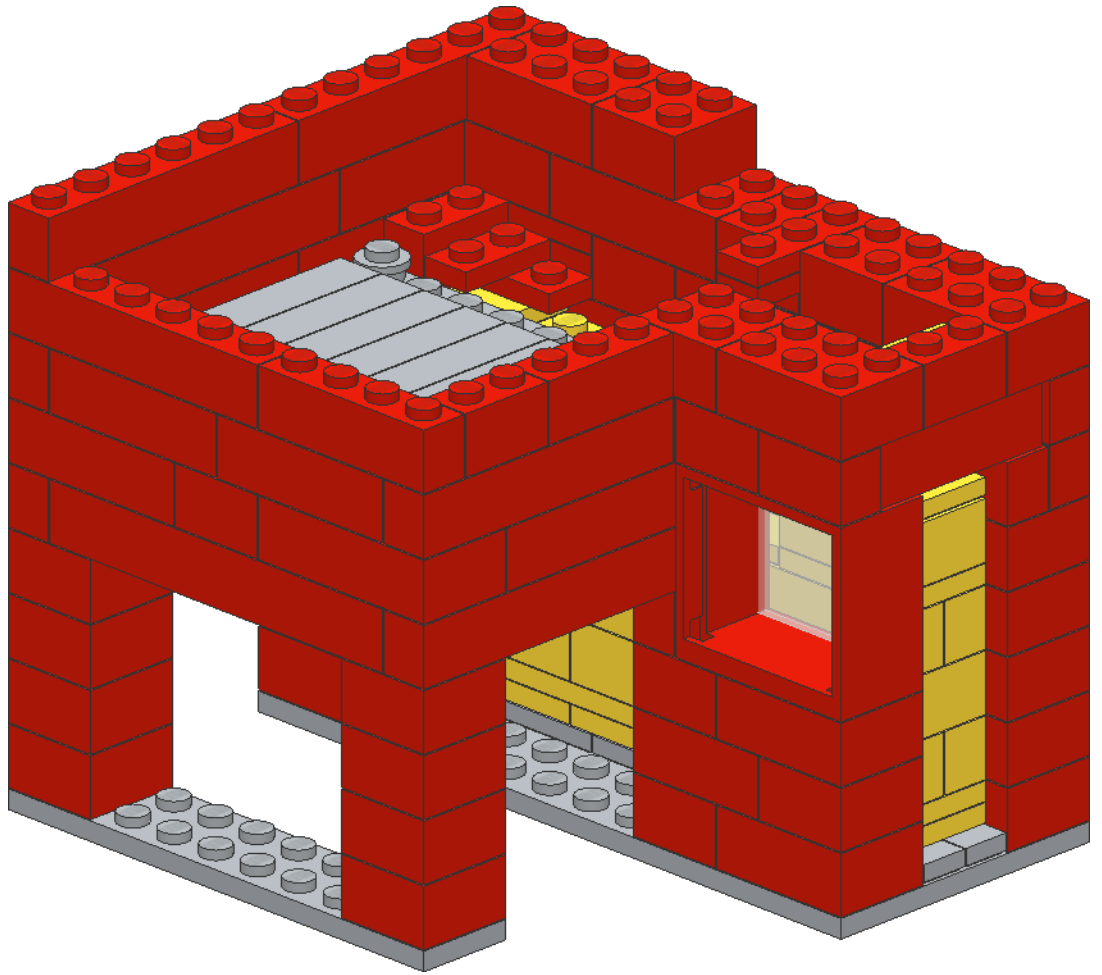
-  1x
-  1x
-  1x
-  2x

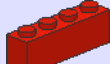

17

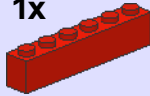
-  1x
-  3x
-  1x
-  1x

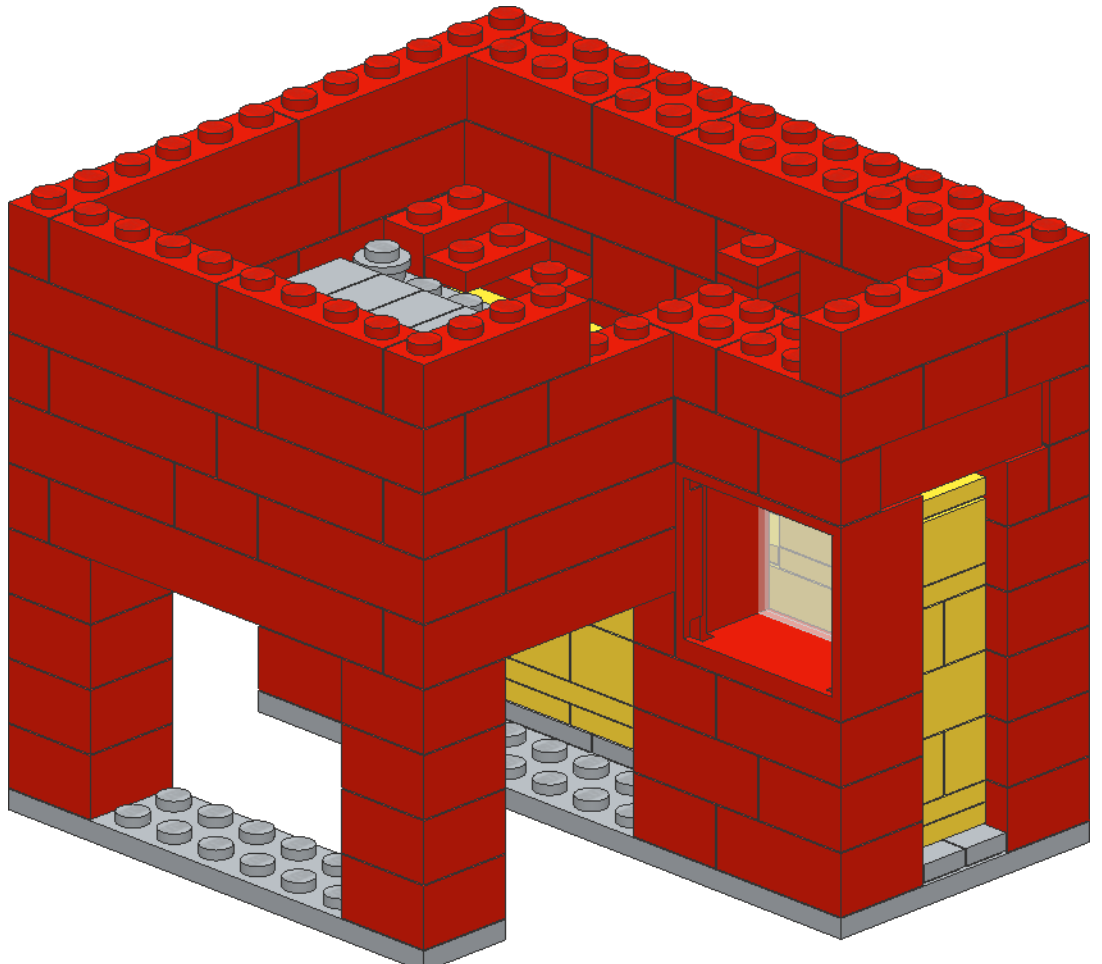

18

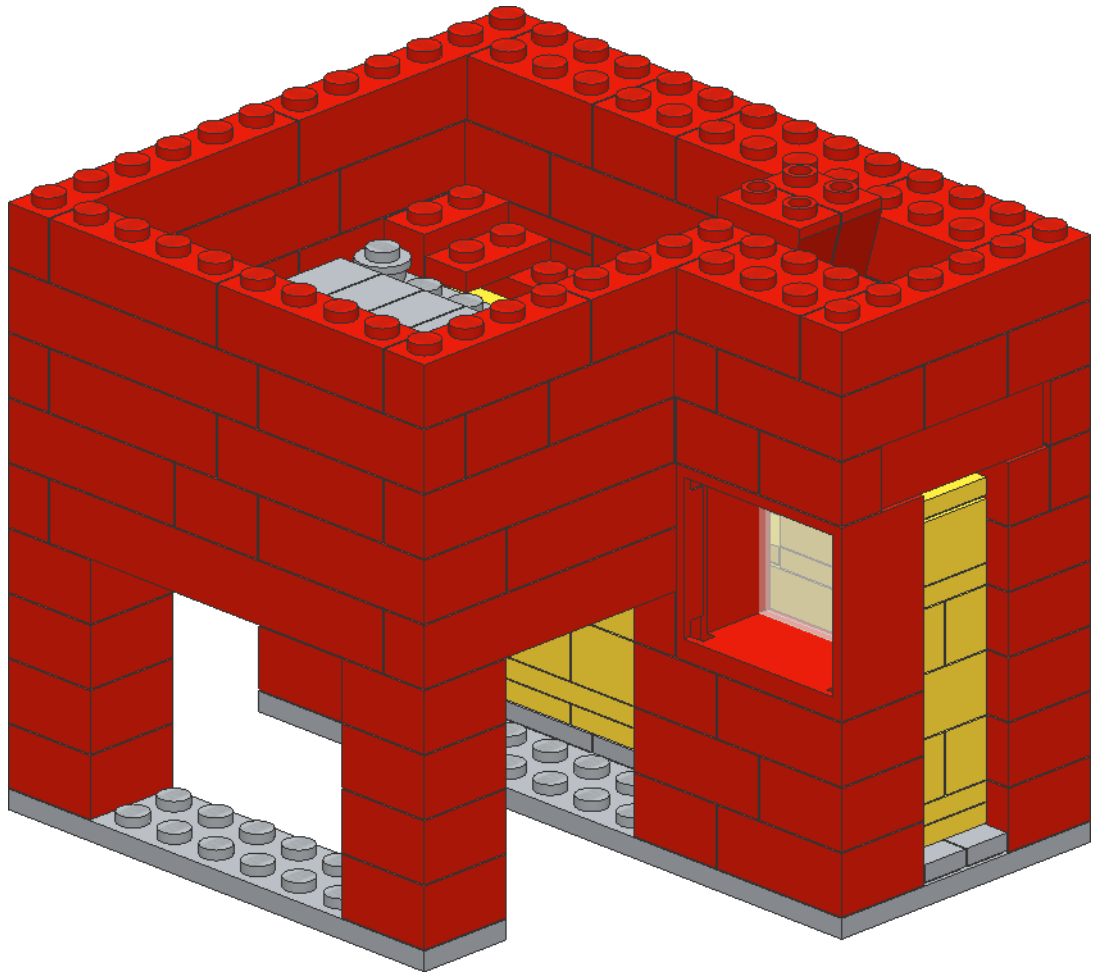
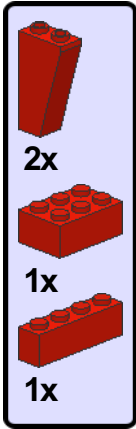

19

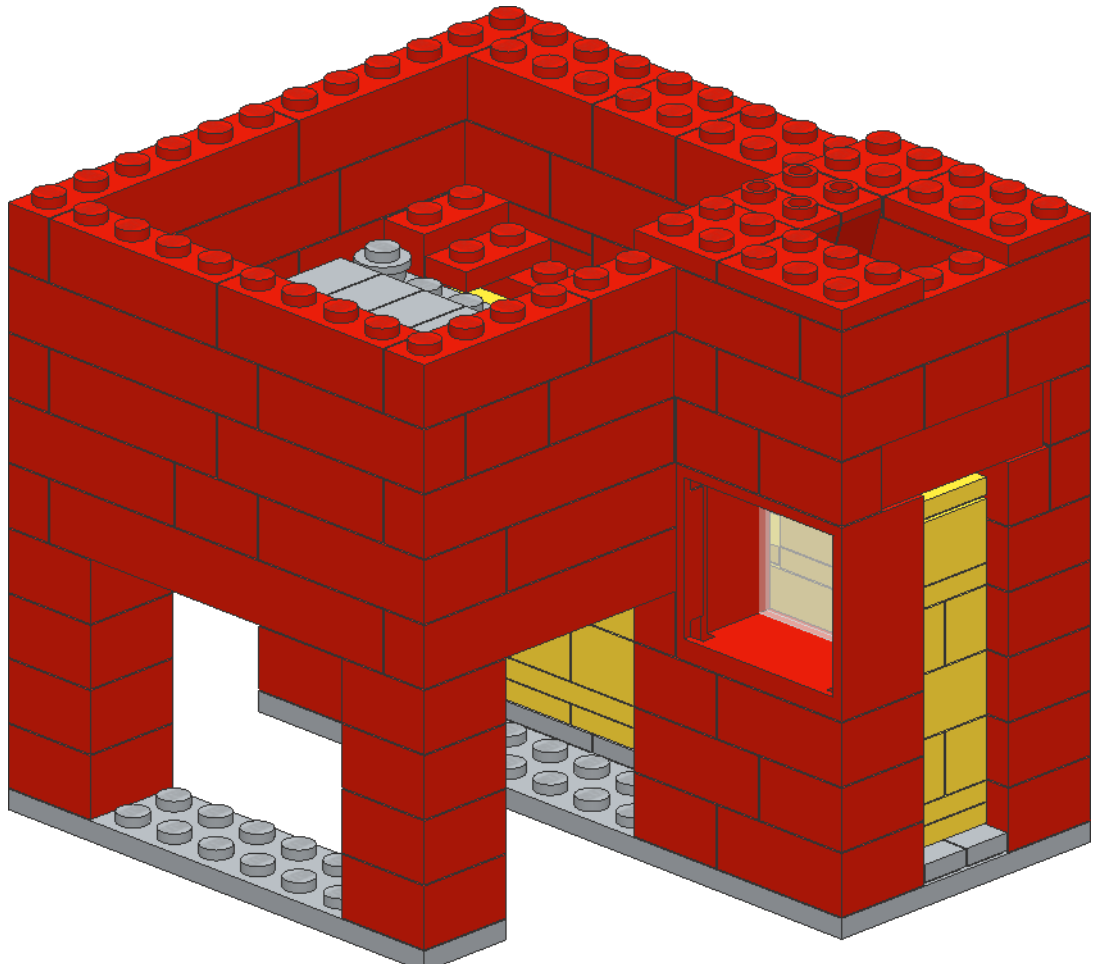
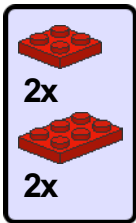

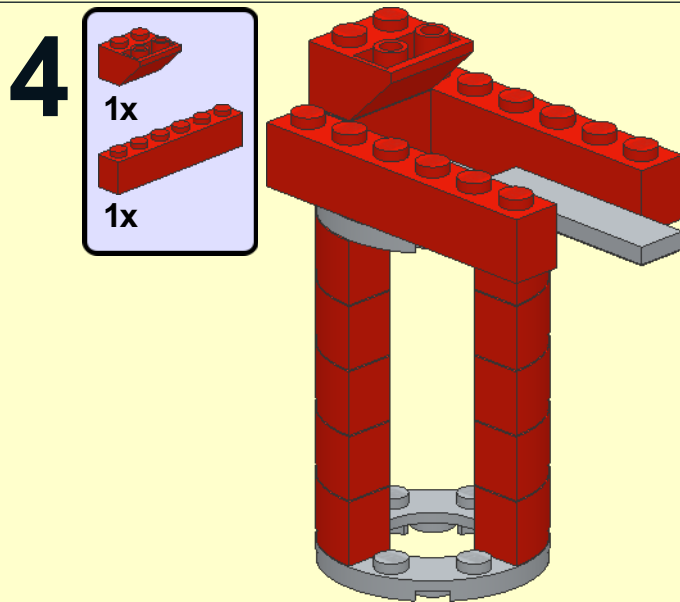
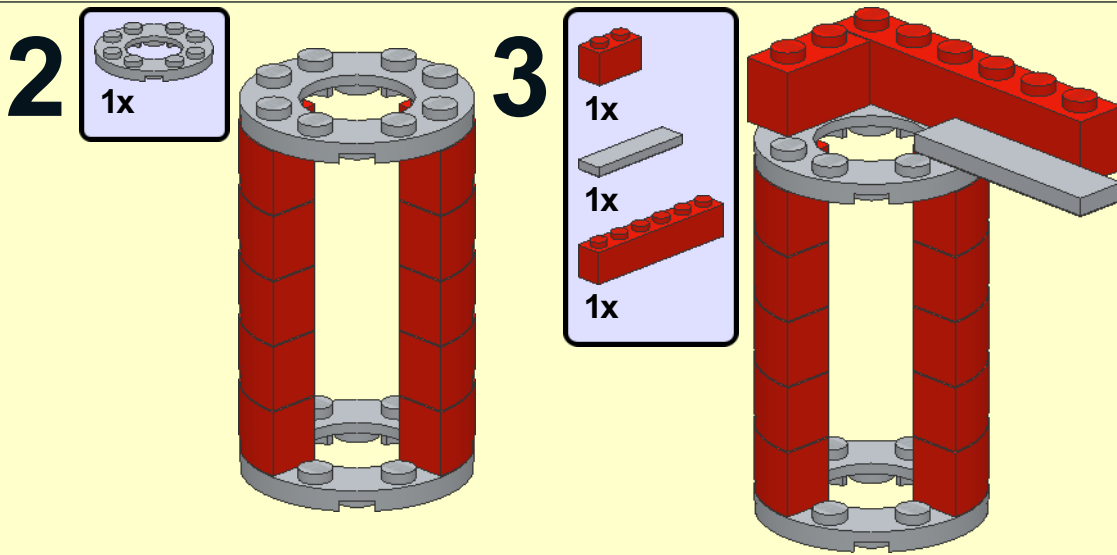
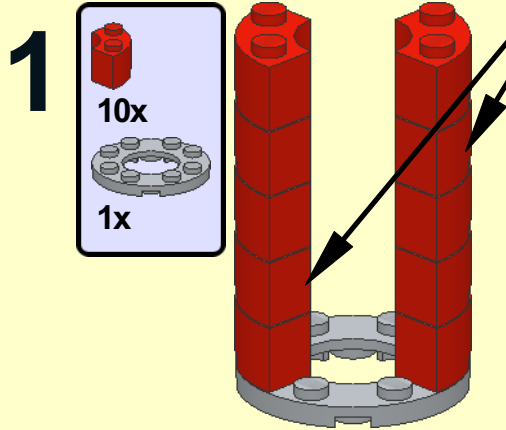
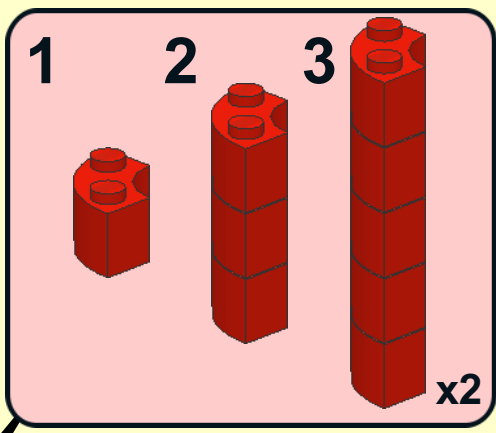

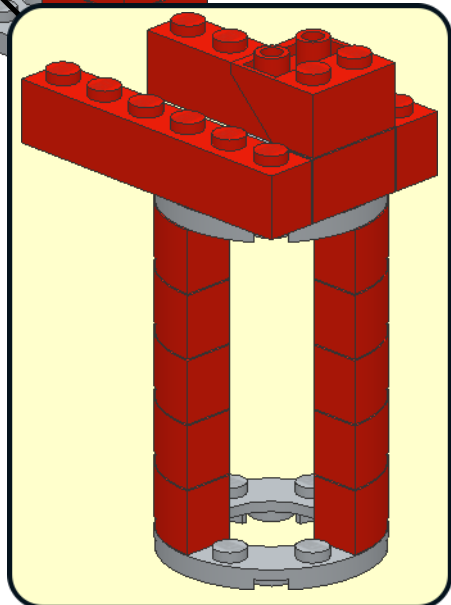
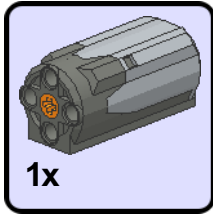
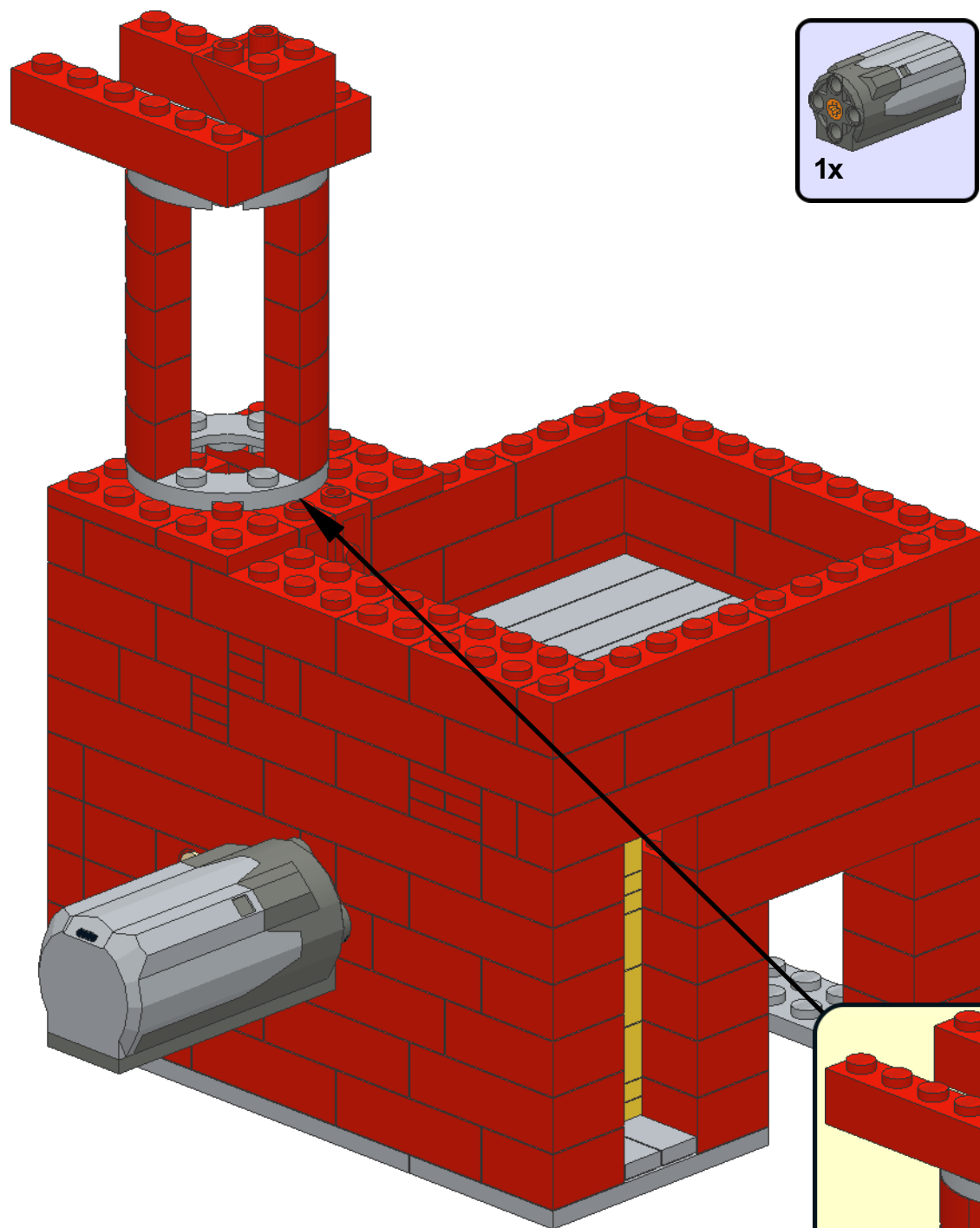

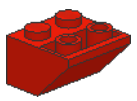

1x

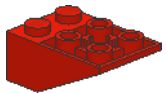

1x

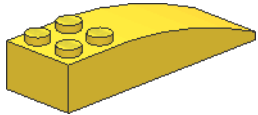

1x

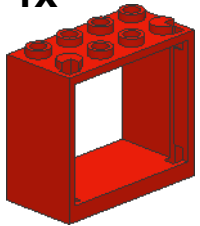

1x

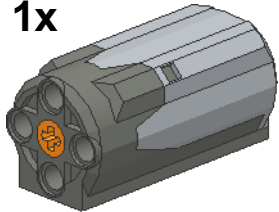

1x



2x



1x

3

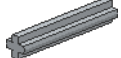

1x



1x

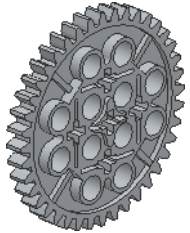

1x

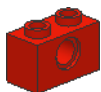

1x

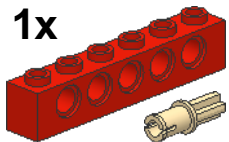

1x



1x



3x

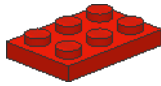

3x

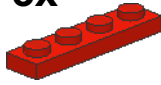

1x

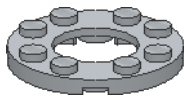

2x



4x

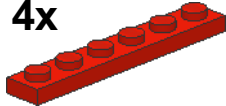

1x

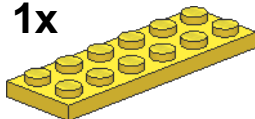

3x

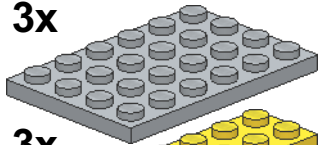

3x



1x



1x

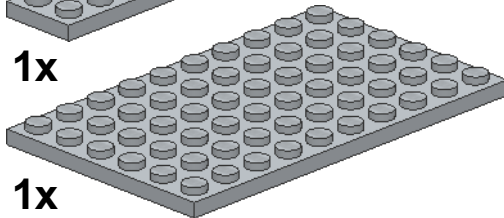

1x



1x

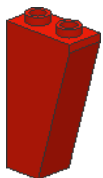

2x

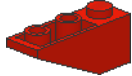

2x

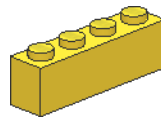

3x

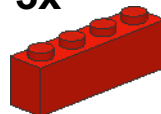

12x

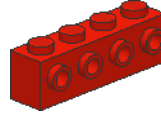

1x

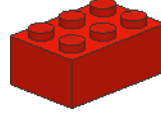

13x

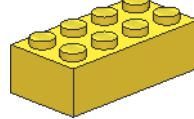

3x

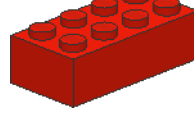

12x

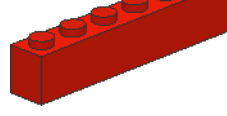

16x

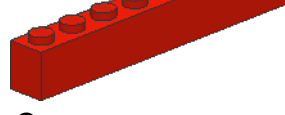

3x



1x



2x



8x



3x

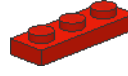

2x

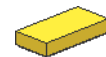

2x



1x

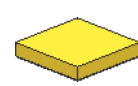

4x

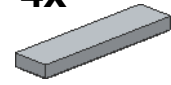

1x



10x



2x



10x



3x



12x



4x

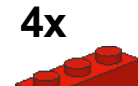

4x



4x



23x



4x